

## „Spectrum of Modern Fuze Batteries“



60<sup>th</sup> Annual Fuze Conference  
May 11<sup>th</sup>, 2017  
Matthias Franz  
Diehl & Eagle Picher GmbH

# Overview

- ◆ Primary Design Features of Fuze/ Reserve Batteries
- ◆ Assembly and Function
- ◆ Large Caliber Reserve Batteries for Artillery and Navy
- ◆ Medium Caliber miniaturized Reserve Batteries
- ◆ Overview and samples in production
- ◆ Conclusions

# Reserve Battery Design

## ◆ Primary Design Features of all Reserve Batteries

- Lithium Metal Battery
- Lithium Thionylchloride electrolyte ( $\text{LiSOCl}_2$ )
- glass ampoule
- release mechanism/activation mechanism
- metal to glass seal
- hermetically sealed stainless steel case
- 100 % helium leak test



Cells

Activation Mechanism

Housing

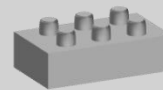
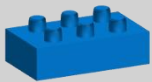

Ampoules



Header

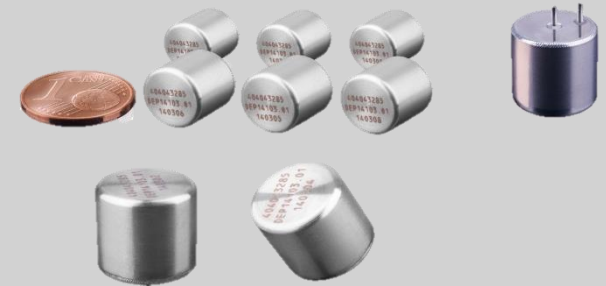
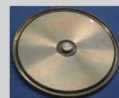
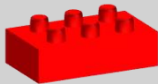
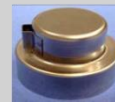
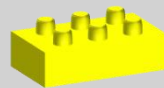

# Large Caliber Group Reserve Batteries



# Cross-sectional View Large Caliber Battery

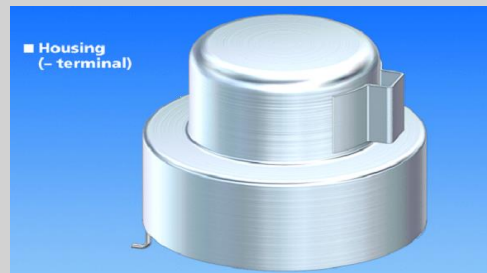
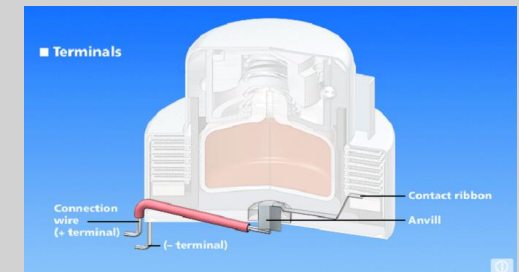
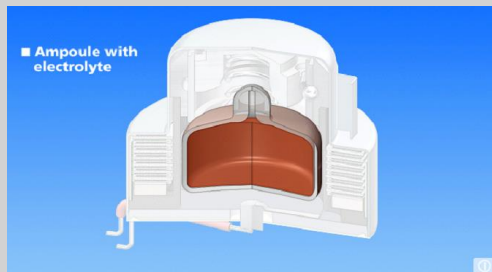
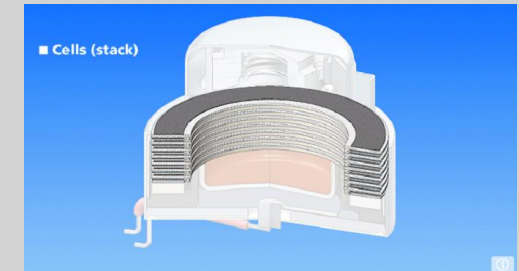
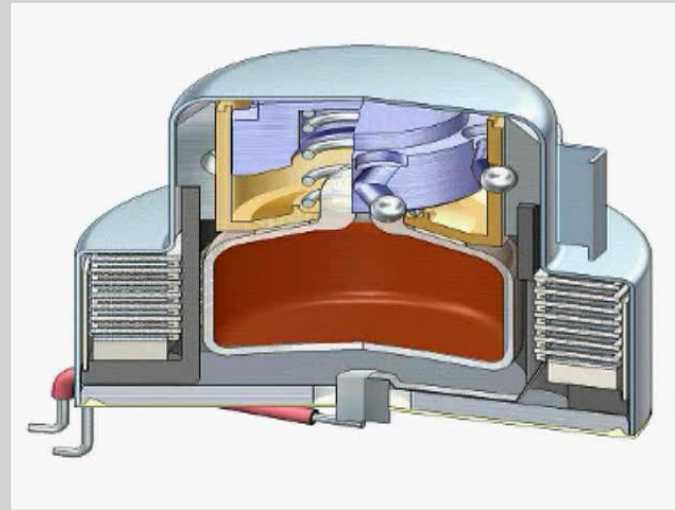
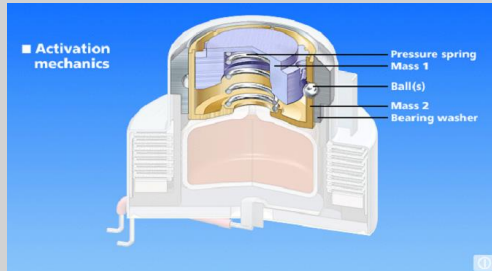



# Battery for a Modular Construction System

*Header*

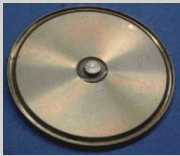
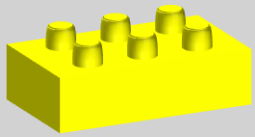

*Housing*

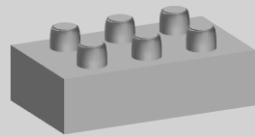

*Cells*

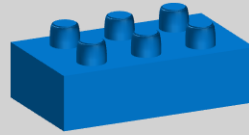

*Ampoules*

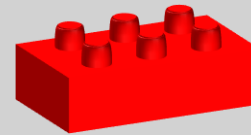

*Activation Mechanism*

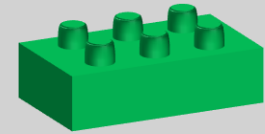

*Main components  
for a Reserve  
Battery*

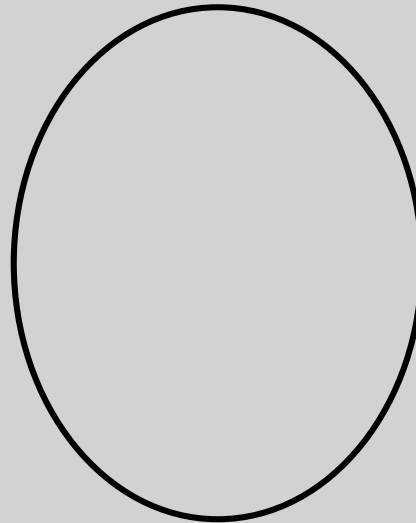

# Variety for the Modular Construction System

*Cells*

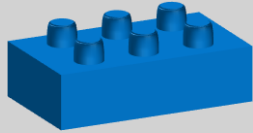

*Ampoules*

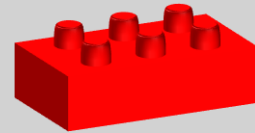

*Activation Mechanism*

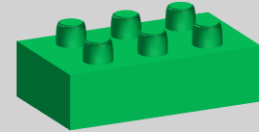

# Battery as a Modular Construction System



*examples in production*

*Cells*

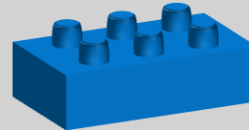

*Activation Mechanism*

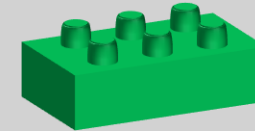

Battery Type	Serial Cells	Parallel Cells	AM
DEP-14001	7	0	1,000g or 5,000g
DEP-14012	8	0	1,000g or 5,000g
DEP-14017	5	2	1,000g or 5,000g
DEP-14015	9	0	1,000g or 5,000g
DEP-14016	4	2	1,000g or 5,000g
DEP-14018	3	2	1,000g or 5,000g
DEP-14012	3	0	1,000g or 5,000g
DEP-14020	2	0	1,000g or 5,000g
DEP-14021	1	2	1,000g or 5,000g



# Medium Caliber Group Reserve Battery

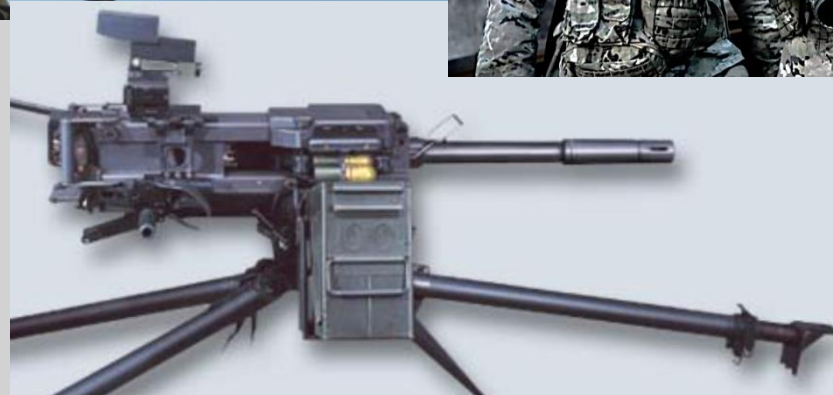
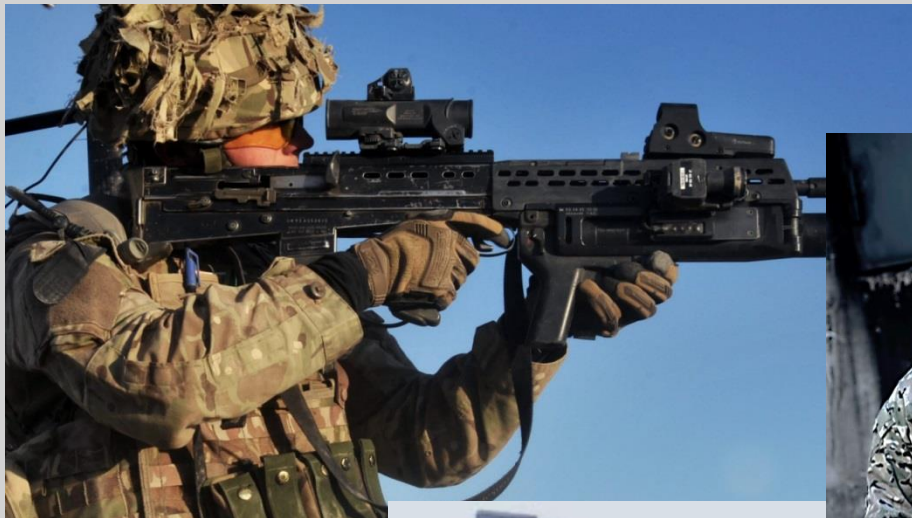

# Variety for the Modular Construction System

*Cells*

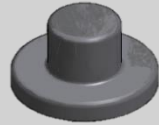
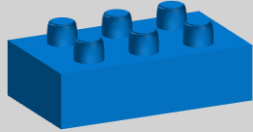

*Ampoules*

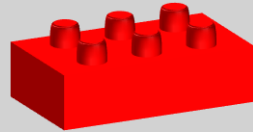

*Activation Mechanism*

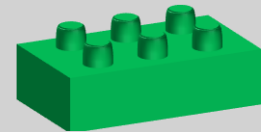

# Battery as a Modular Construction System



examples

Cells

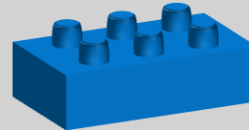

Activation Mechanism

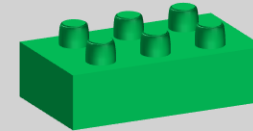

Battery Type	Serial Cells	Parallel Cells	AM
DEP-14202.01	2	0	7,000g
DEP-14202.02	2	0	7,000g
DEP-14202.03	3	0	7,000g
DEP-14202.04	4	0	7,000g

**No Spin Version**  
**High Spin Version**  
**High Spin Version**  
**High Spin Version**

# Variety for the Modular Construction System

*Cells*

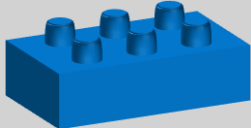

*Ampoules*

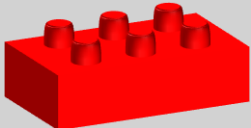

*Activation Mechanism*

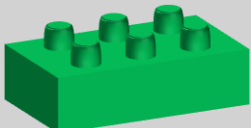

# Battery as a Modular Construction System



*examples in production*

Cells

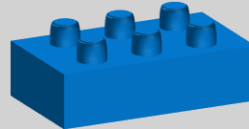

Activation Mechanism

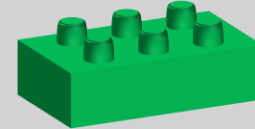

Battery Type	Serial Cells	Parallel Cells	AM
DEP-14103.01	1	0	7,000g

**No/ Low Spin Version**

# Nothing is impossible

## 1. Release Mech.

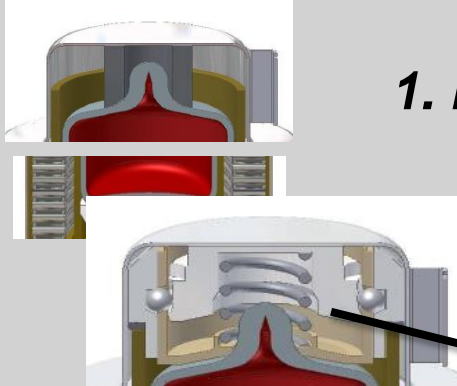

## 2. Ampoule



## 3. Cell



Cell  $\varnothing = 30\text{ mm}$



Cell  $\varnothing = 17\text{ mm}$



Cell  $\varnothing = 9\text{ mm}$



# Reserve Battery-Versions Overview

“Large”	“Large”	“Midi”	“Mini”	“Ultra Mini”
DEP14001	DEP14007/17/12	DEP14020/21	DEP14202	DEP14103
1 – 10 cells	1 – 10 cells	1 – 2 cells	1 – 2 cells	1 cell
7 cells	8 cells	2 cells	2 cells	1 cell
25.2 V	28.8 V	7.2 V	7.2 V	3.6 V

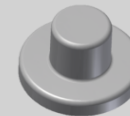
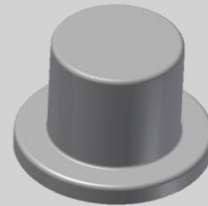
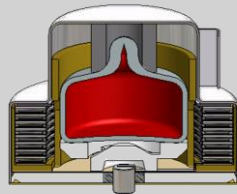
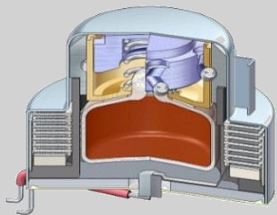

# Future developments

- ◆ 1-cell battery for high spin application
- ◆ Development on super quick in barrel activation batteries for artillery and naval versions
- ◆ Development of limited capacity for batteries, to be used in applications where de-energizing is requested for failure mode

# Conclusion

- ◆ Most batteries in the past were designed only for one application in mind and were used by as many customers
- ◆ Due to a modular construction of the subsystems a battery could be designed for almost all applications and will cover your requirements
- ◆ In lab-testing for the batteries is available in short time, see next session

Thank you for your attention!

Questions?

# Diehl & Eagle Picher Contact

## ◆ How to Contact us

- Presenter Matthias Franz
- Mail Diehl & Eagle Picher GmbH  
Fischbachstrasse 20  
90552 Roethenbach a d Pegnitz  
Germany
- Phone +49-911-957-2046
- Fax +49-911-957-2485
- Email [matthias.franz@diehl-eagle-picher.com](mailto:matthias.franz@diehl-eagle-picher.com)
- Web [www.battery.de](http://www.battery.de)